

NurseCall Relay Unit

F.01U.252.722 | V1 | 2011.12



BOSCH

en User Manual

Table of Contents

1	Safety instructions	5
1.1	Importance of safety instructions	5
1.2	Disregarding safety rules	5
1.3	Environmental conditions	5
1.4	General safety instructions	5
1.4.1	Observation and information	6
2	Description	7
2.1	General description	7
2.1.1	Top view	7
2.1.2	Bottom view	8
2.1.3	Front view	9
2.1.4	Relay Unit rear view	9
2.1.5	Relay Plus Unit rear view	9
2.2	Detailed description	10
2.2.1	Loudspeaker	10
2.2.2	Display	10
2.2.3	Keyboard	10
2.2.4	RS-485 interface	12
2.2.5	Antenna	12
3	Installation	13
3.1	Unpacking	13
3.1.1	List of contents	13
3.2	Installation	14
3.2.1	Generalities	14
3.2.2	Installation on a piece of furniture	14
3.2.3	Wall installation	14
3.2.4	Installing the antenna	14
3.2.5	Connecting to the mains	15
3.2.6	Setting the jumpers on the communication board on the Relay Plus Unit	16
3.2.7	Connecting the RS-485	17
3.2.8	Connecting the RS-232 to the Relay Plus Unit	18
3.2.9	Setting the 100 Ohm termination jumper	18
4	Programming	19
4.1	Generalities	19
4.1.1	Using the keyboard	19
4.1.2	Exit and cancel entries	19
4.1.3	Key not allowed	19
4.1.4	Locking and unlocking the keyboard	19
4.1.5	Programming time-out	19
4.2	First use	20
4.2.1	List of original factory settings	20
4.2.2	Parameters set by the NurseCall Main Unit	20
4.2.3	Locating mode and identification number	20

4.3	Special settings	21
4.3.1	Displaying the firmware version	21
4.3.2	Resetting all the parameters and buffers	21
4.3.3	Assistance and fire priority	21
4.3.4	Assistance and fire non priority	22
4.3.5	Special texts in German	22
4.3.6	Standard texts in German	22
4.4	Printer/display setup on the Relay Plus Unit	22
4.4.1	Access to the printer/display setup menu	22
4.4.2	Selection "None"	23
4.4.3	Selection "Printer"	23
4.4.4	Selection "DISPLAY ZETTLER"	23
4.4.5	Selection "DISPLAY NORSK"	24
5	Operation	25
5.1	Adjusting the loudspeaker volume	25
5.2	Consulting the alarm or event buffer	25
5.2.1	Switching between alarm and event buffers indication	26
5.2.2	Display indications	26
5.2.3	The green button does not work	27
5.2.4	Disconnecting a Relay Unit	27
6	Maintenance	28
6.1	Checking the system	28
6.2	Monitoring the power supply	28
6.3	Monitoring the backup battery	28
6.4	Cleaning	29
6.5	Parts replacement	29
6.5.1	Disassembling the unit	29
6.5.2	Backup battery replacing	30
7	Disposal	31
7.1	Disassembly	31
7.2	Returning to the manufacturer	31
7.3	Materials	31
7.4	Battery	31
A	Appendix	32
A.1	Electrical specifications	32
A.2	Dimensions and weight	32
A.3	Environmental conditions	32
A.4	List of criteria	33
A.5	Connectors	34
A.5.1	LINE socket (unit bottom)	34
A.5.2	Power socket (unit bottom)	34
A.5.3	RS-232 socket (Relay Plus Unit rear)	34
A.5.4	RS-485 socket (unit rear)	34

1 Safety instructions

**NOTICE!**

The user and installer should read and understand this chapter before any intervention on the NurseCall Relay Unit.

1.1 Importance of safety instructions

Each safety and protection instruction in this manual must be adhered to in order to avoid personnel injuries, property damages or environmental pollution.

In a similar manner, the legal bylaws, the measures in prevention of accidents and for the protection of the environment, as well as the recognized technical rules aiming at appropriate and safe working conditions which as applied in the country and at the place of use of the NurseCall Relay Unit must be adhered to.

1.2 Disregarding safety rules

Disregarding the safety rules, as well as existing legal and technical regulations, may lead to accidents, to property damages or to environmental pollution.

1.3 Environmental conditions

**NOTICE!**

The NurseCall Relay Unit must not be located near a water tap or any other source of water. The electrical safety of the unit is only guaranteed if the electrical installation is conform to the national regulation and if this installation works properly.
The NurseCall Relay Unit may not be used in buildings prone to fire and explosion hazards.

**NOTICE!**

The NurseCall Relay Unit may not be used under exposure to the direct sunlight, to heat, to dust or to an excessive humidity (only use the equipment in a clean environment).

► Install the NurseCall Relay Unit in a dry place, away from any source of heat.

**CAUTION!**

Interferences
Avoid immediate proximity to other electric devices such as a television.

1.4 General safety instructions

**DANGER!****Electrocution**

During maintenance operations, when the NurseCall Relay Unit is powered and its casing is removed, it may not be left unattended.

**CAUTION!**

The NurseCall Relay Unit may only be connected to the electrical sources as described in *Section A.1 Electrical specifications, page 32.*

**CAUTION!**

Maintenance and repairs may only be performed in conformance with the instructions and by authorized technical personnel only.

The sole possession of the user manual does not allow the personnel to perform any kind of repair on the NurseCall Relay Unit.

Take into account all the warnings and follow all the instructions displayed on the NurseCall Relay Unit and those which are printed in the documentation.

Never try to use replacement pieces other than those authorized by the manufacturer of the NurseCall Relay Unit.

**CAUTION!**

It is mandatory to use the products specified in the present user manual to clean the NurseCall Relay Unit. If you plan to use another product, only do so after having obtained the authorization of the manufacturer.

**DANGER!**

The NurseCall Relay Unit contains highly sensitive electronic components. It should be opened only in an **ESD** protected environment with respect to the following precautions:

1. Discharge yourself from electrostatic loads by touching a grounded conductive surface before opening the unit.
2. Avoid touching conductive parts inside the unit if not absolutely necessary.

**CAUTION!**

Never let any liquid enter the system. In case of liquid spill inside the NurseCall Relay Unit, act immediately as follows:

1. Switch off the unit using the main switch under the casing.
2. Unplug the power supply adaptor.
3. Dry up the unit.
4. Clean the unit.
5. Check that the unit switches on correctly.

1.4.1**Observation and information**

In case of defective operation or any other technical incident for which no remedy is described in this manual, please contact immediately your local representative.

2 Description

2.1 General description

2.1.1 Top view

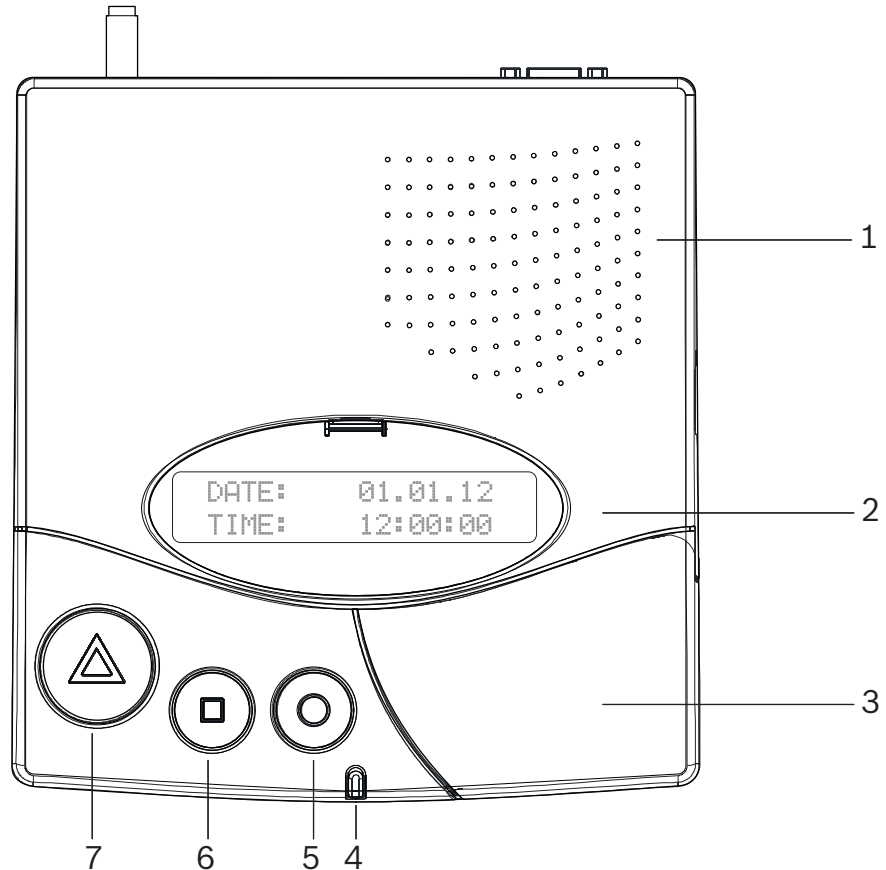

1. Loudspeaker.
See *Section 2.2.1 Loudspeaker, page 10.*
2. Display.
See *Section 2.2.2 Display, page 10.*
3. Keyboard, under the cover.
See *Section 2.2.3 Keyboard, page 10.*
4. LED Indicator
5. **Yellow** button
Used to view more details about the event or alarm currently displayed (date and time, position, etc...).
6. **Green** button
Used to acknowledge an alarm locally, see *Section 5.2.3 The green button does not work, page 27.*
7. **Red** button with light
This button is not used. Pressing the button does not activate a function.
The light blinks red during an alarm.

2.1.2 Bottom view

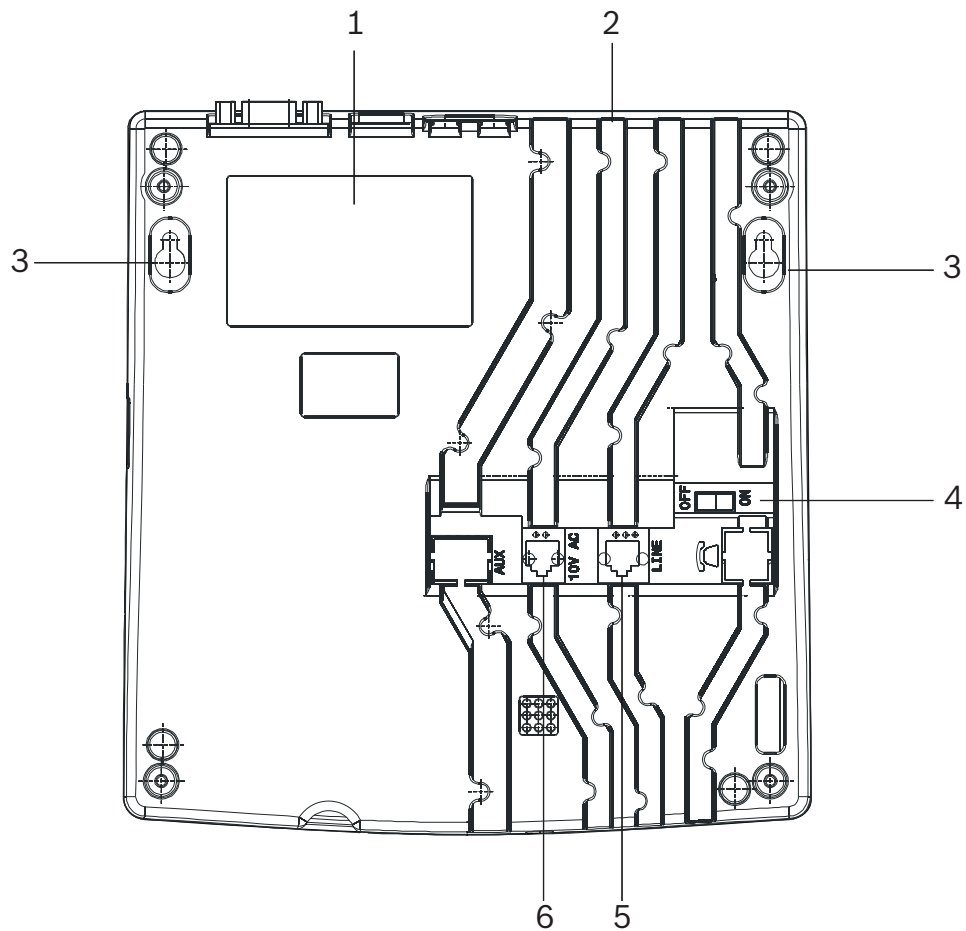

1. Identification label.
2. Cable channels.
3. Wall mounting holes (distance between holes, 157 mm).
See *Section 3.2.3 Wall installation, page 14* for a detailed description.
4. ON/OFF switch.
5. LINE socket, used for firmware update.
See *Section A.5.1 LINE socket (unit bottom), page 34* for wiring.
6. 10V AC socket.
See *Section A.5.2 Power socket (unit bottom), page 34* for wiring.

2.1.3 Front view

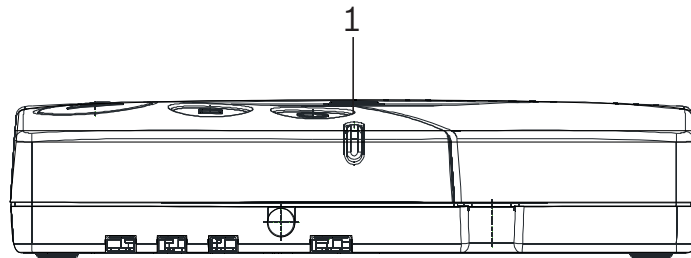

1. LED Indicator

Status	LED
Standby mode (normal operation)	Green (permanent)
Backup battery low	Green (blinking)
Power supply disconnected	Green (flashing)
Help, assistance or fire	Red (blinking)

2.1.4 Relay Unit rear view

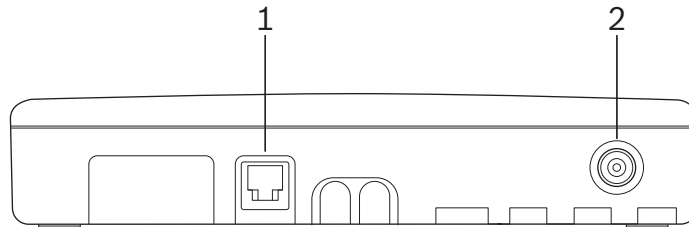

1. RS-485 connector.
See Section A.5.4 RS-485 socket (unit rear), page 34 for wiring.
2. Antenna connector

2.1.5 Relay Plus Unit rear view

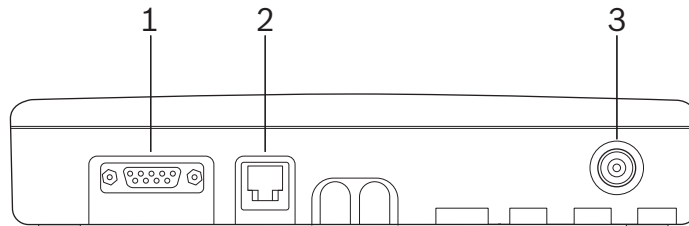

1. RS-232 connector, used for the printer/display interface of the Relay Plus Unit.
See Section A.5.3 RS-232 socket (Relay Plus Unit rear), page 34 for wiring.
2. RS-485 connector.
See Section A.5.4 RS-485 socket (unit rear), page 34 for wiring.
3. Antenna connector

2.2 Detailed description

2.2.1 Loudspeaker

When one of the following alarms or messages is received by the NurseCall Relay Unit, the internal loudspeaker is activated until acknowledgement.

Status	Loudspeaker
Power supply disconnected	Dual-tone beep every minute
Call for help, reserve call, technical call	4 second interval, one tone
Error message	15 second interval, one tone
Disconnection of a relay unit from RS485-bus	1 minute interval, one tone
Call for assistance / fire alarm	Continuously dual-tone beep
Local acknowledgement	Short beep

2.2.2 Display

The NurseCall Relay Unit is equipped with a 2 x 20 characters display that guides the operator during the programming. During normal operation, alarms and messages are displayed.

```
NurseCall Relay Unit
V2.02 BN111.242.00A
```



NOTICE!









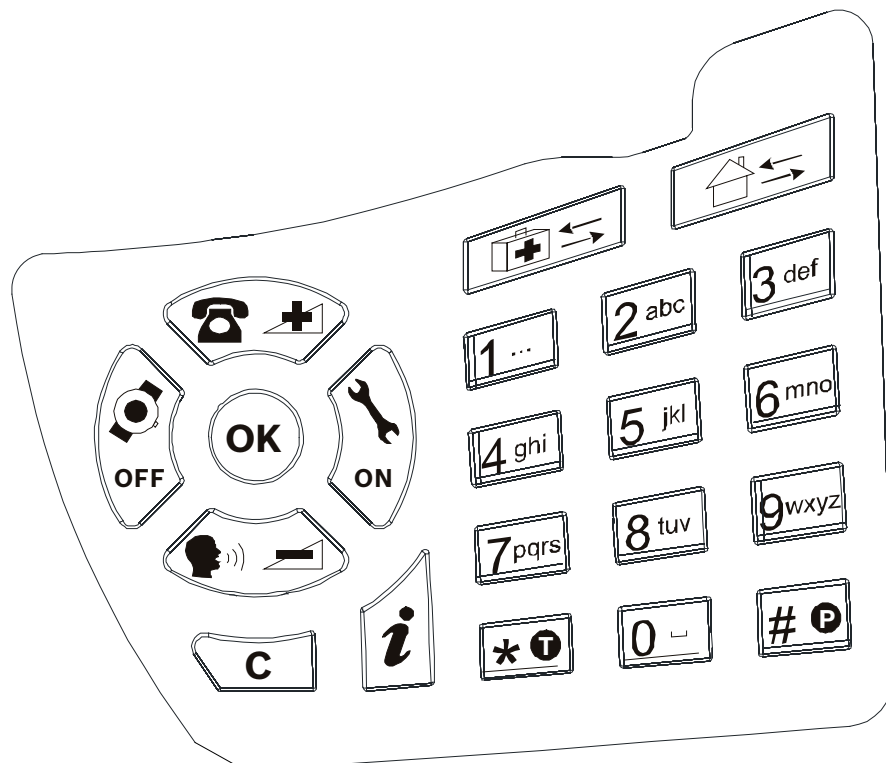







This user manual is written for the unit language **English USA**. Certain displays may differ for the unit language **English UK**.

2.2.3 Keyboard

Keyboard

The keyboard has 21 alphanumeric keys. They are used to perform special commands or during normal operation.



Keys	Function
	Access to the printer/display setup (Relay Plus Unit only) See <i>Section 4.4 Printer/display setup on the Relay Plus Unit, Page 22.</i>
	Increase the volume of the loudspeaker. See <i>Section 5.1 Adjusting the loudspeaker volume, page 25.</i>
	Decrease the volume of the loudspeaker. See <i>Section 5.1 Adjusting the loudspeaker volume, page 25.</i>
	Scroll down to the previous alarm/event. See <i>Section 5.2 Consulting the alarm or event buffer, Page 25.</i>
	Scroll up to the next alarm/event. See <i>Section 5.2 Consulting the alarm or event buffer, Page 25.</i>
	Confirm a value or a command.
	Cancel an entry or a command.
	Check the status of the backup battery. See <i>Section 6.3 Monitoring the backup battery, page 28.</i>
	Not used.
 to 	Enter a value, such as special codes. See <i>Section 4.3 Special settings, Page 21.</i>
	Not used.
	Not used.
	Enter a value or launch the event/alarm display mode. See <i>Section 5.2.1 Switching between alarm and event buffers indication, Page 26.</i>
 then 	Lock and unlock the keyboard.

2.2.4

RS-485 interface

One NurseCall Main Unit and up to 32 NurseCall Relay Units can be connected by a RS-485 bus. The bus must be connected to pins 2 and 5 of the RS-485 socket.

- ▶ For connector wiring, see *Section A.5.4 RS-485 socket (unit rear), page 34*.



NOTICE!

Keep polarity equal when connecting further units to the RS485 bus!



NOTICE!

Maximum RS485-bus length: 1200 m.
Use only one twisted pair cable for the interconnection.



NOTICE!

The receiver units located at the two ends of the bus must be terminated with a 100 Ohm resistor. See *Section 3.2.7 Connecting the RS-485, page 17* for more information about the jumper setting.

In this configuration, you always should connect the NurseCall Main Unit first. The NurseCall Relay Units must then be connected to the RS485-bus one by one, not at the same time.

Relay output

In the same connector, a potential free contact is available. It is a low current switching contact. The relay (potential free, switching power max. 48 V / 0.5 A) is activated at a call for help, call for assistance or fire alarm. This relay can be set as closing or switching contact (cycle of 10 seconds on / 10 seconds off). This feature can be used to drive a signal lamp for example.

- ▶ For connector wiring, see *Section A.5.4 RS-485 socket (unit rear), page 34*.
- ▶ For relay setting, see the user manual of the NurseCall Main Unit.

2.2.5

Antenna

The antenna is connected to the NurseCall Relay Unit using the adapter supplied with the unit.

- ▶ See *Section 3.2.4 Installing the antenna, page 14*.

3 Installation

3.1 Unpacking

The NurseCall Relay Unit is carefully packed for transportation.

The components contained in the box are protected, but should be handled with care.

Store the packaging material for further use (storage or transport).

1. Take all components out of the box and place the NurseCall Relay Unit on the working space.
2. Check each component in the box, in accordance with the list of contents below.
3. Check that the NurseCall Relay Unit and its accessories have not been damaged during transportation.

In case of defective or missing equipment, do not try to install the NurseCall Relay Unit.

- ▶ Contact immediately your local representative.

3.1.1 List of contents

Description
NurseCall Relay Unit
Power supply adaptor (Europe) 230VAC/10VAC or Power supply adaptor (UK) 230VAC/10VAC UK or Power supply adaptor (US) 115VAC/10VAC
Antenna 434MHz 1/2 L=34 cm FME
Straight adapter BFME-TNC
Right angled bended adapter BFME-ETNC
2 m Cable FCC 6/4
NurseCall Relay Unit User Manual

3.2 Installation

3.2.1 Generalities

- ▶ Install the NurseCall Relay Unit in a dry place, away from any source of heat.

Tools required:

- Torx T20 screwdriver.
- Torx T10 screwdriver.

3.2.2 Installation on a piece of furniture

It is recommended to place the NurseCall Relay Unit on a non-slippery surface. However, do not place anything (blanket or lace) on top of the unit.

3.2.3 Wall installation

You can fasten the NurseCall Relay Unit on a smooth wall surface using two screws. The distance between holes is 157 mm.

The power line cord should be placed inside the cable channels on the bottom of the NurseCall Relay Unit.

3.2.4 Installing the antenna

1. Use the straight adapter (4) for wall installation or the right angled bended adapter (3) for installation on a piece of furniture.

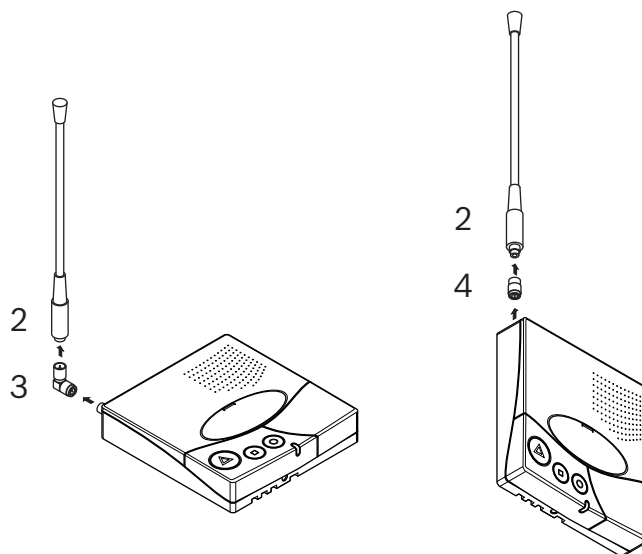

2. Fasten the adapter (3) or (4) on the antenna connector (1).

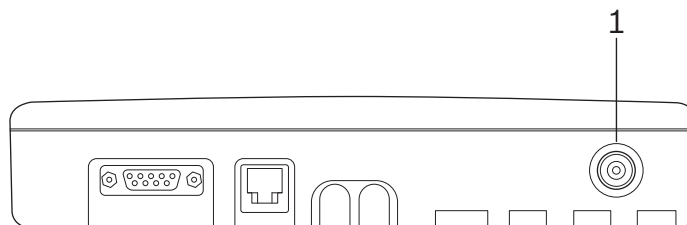

3. Fasten the antenna (2) on the adapter.

3.2.5 Connecting to the mains

The NurseCall Relay Unit is powered by an adaptor (230/10 VAC or 115/10 VAC).



CAUTION!

In case of a different supply, the equipment must fulfill isolation requirements according to EN60950 standard (last edition).

1. Plug the power adaptor into a power outlet placed near the unit. It should be easily accessible at any time.

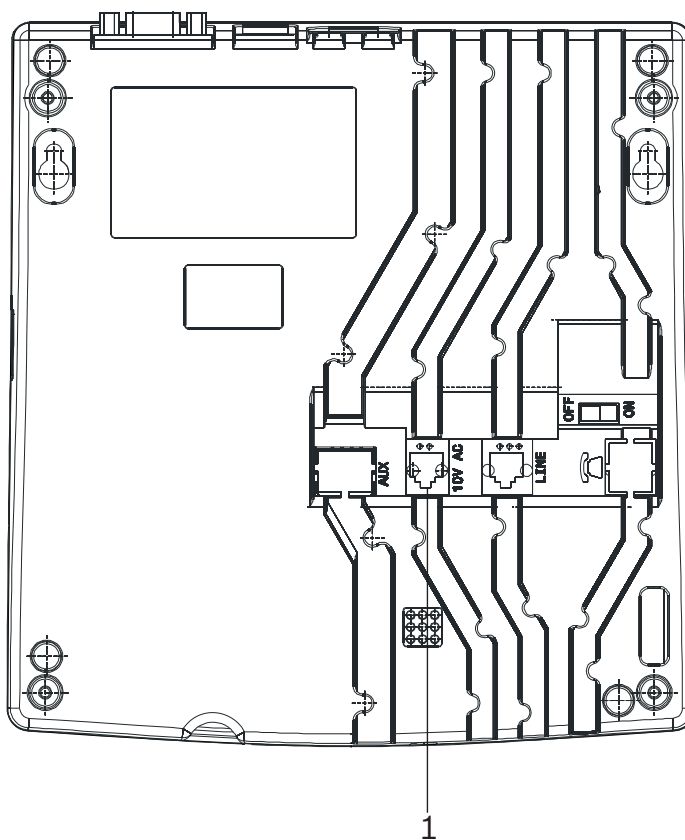

2. Connect the cable to the socket labeled 10V AC (1), under the unit.
For connector wiring, see *Section A.5.2 Power socket (unit bottom)*, page 34.

3.2.6

Setting the jumpers on the communication board on the Relay Plus Unit

1. Disassemble the unit; see *Section 6.5.1 Disassembling the unit, page 29*.
2. Remove the communication board; see *Section Removing the communication board, page 29*.
3. Set the jumpers as required in your configuration. By default the jumpers are set for connection to a Display Zettler.

Setting the jumpers for a Display Zettler:

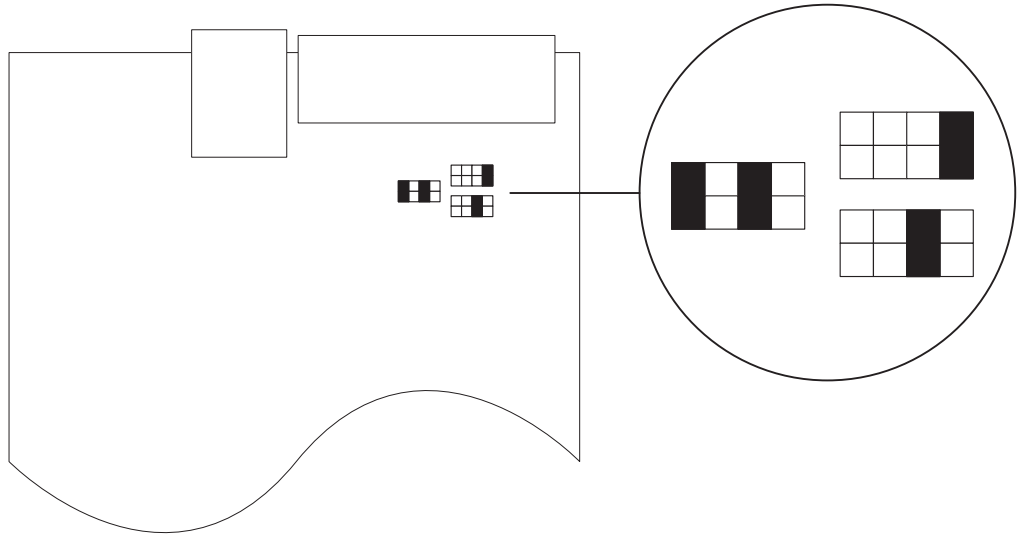

Setting the jumpers for a printer setup or a Display Norsk:

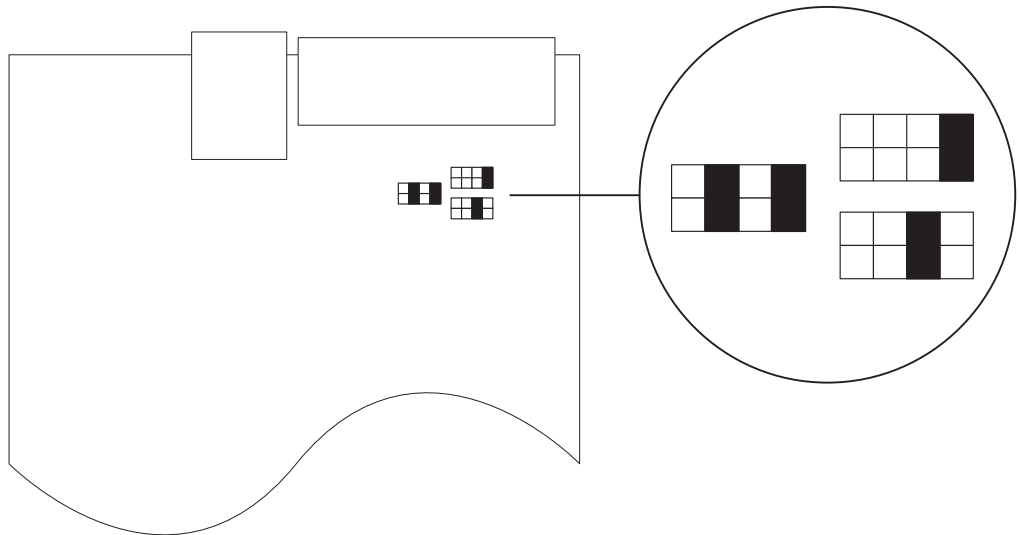

4. Assemble the communication board and the unit. This is basically the reverse of the disassembling procedure, see *Section 6.5.1 Disassembling the unit, page 29*.

3.2.7

Connecting the RS-485

One NurseCall Main Unit and up to 32 NurseCall Relay Units can be connected to an RS-485 bus. Please contact a specialist for a correct installation.

► See Section A.5.4 RS-485 socket (unit rear), page 34 for connector wiring.



CAUTION!

Do not use a star connection for the RS-485 network!

Incorrect connection:

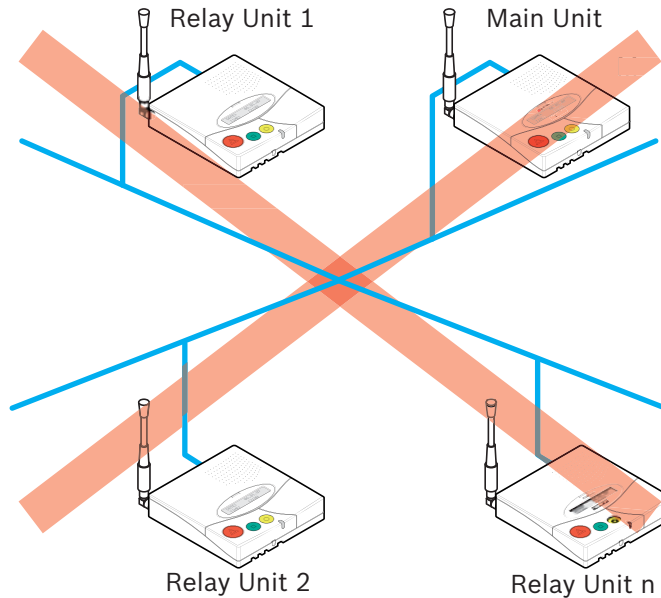

Correct connection:

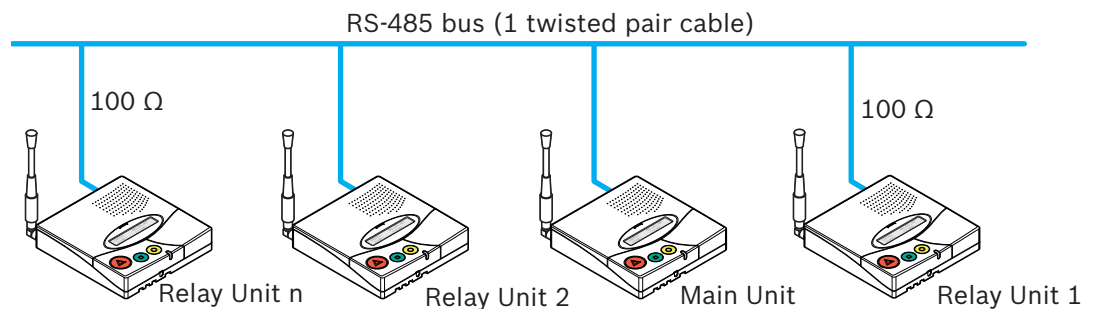

NOTICE!

The NurseCall Main or Relay Units located at the two ends of the bus must be terminated with a 100 Ohm resistor.

3.2.8 Connecting the RS-232 to the Relay Plus Unit

- ▶ Connect the printer or display device to the 9-pole SUB-D connector (1) at the rear part of the housing of the Relay Plus Unit.

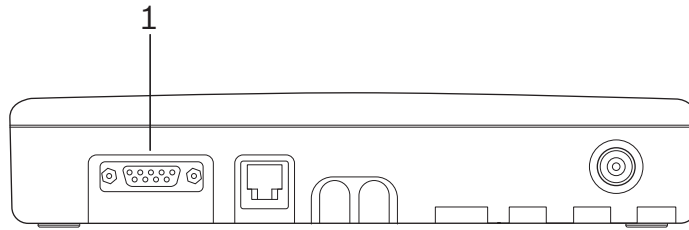

For connector wiring, see *Section A.5.3 RS-232 socket (Relay Plus Unit rear)*, page 34.

3.2.9 Setting the 100 Ohm termination jumper

Within the NurseCall Main or Relay Units, the RS-485 interface can be configured with a jumper.

1. Disassemble the unit as described in *Section 6.5.1 Disassembling the unit*, page 29.
2. Remove the communication board as described in *Section Removing the communication board*, page 29.
3. Put the 100 Ohm termination jumper J112 (1).

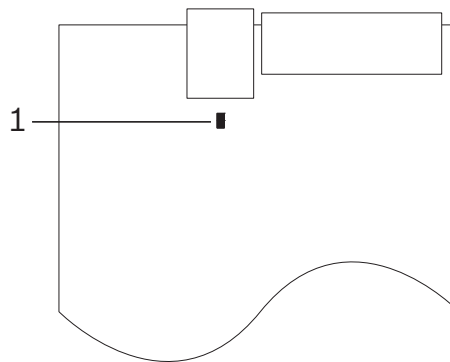

4. Assemble the communication board and the unit. This is basically the reverse of the disassembling procedure, see *Section 6.5.1 Disassembling the unit*, page 29.



NOTICE!

If you do not want to disassemble the NurseCall Relay Unit, you also can short-out pins 3 and 4 of the connector. This has the same effect as the jumper setting described above. See *Section A.5.4 RS-485 socket (unit rear)*, page 34 for connector wiring.

4 Programming

4.1 Generalities

4.1.1 Using the keyboard

- ▶ Open the cover carefully and use the keyboard.

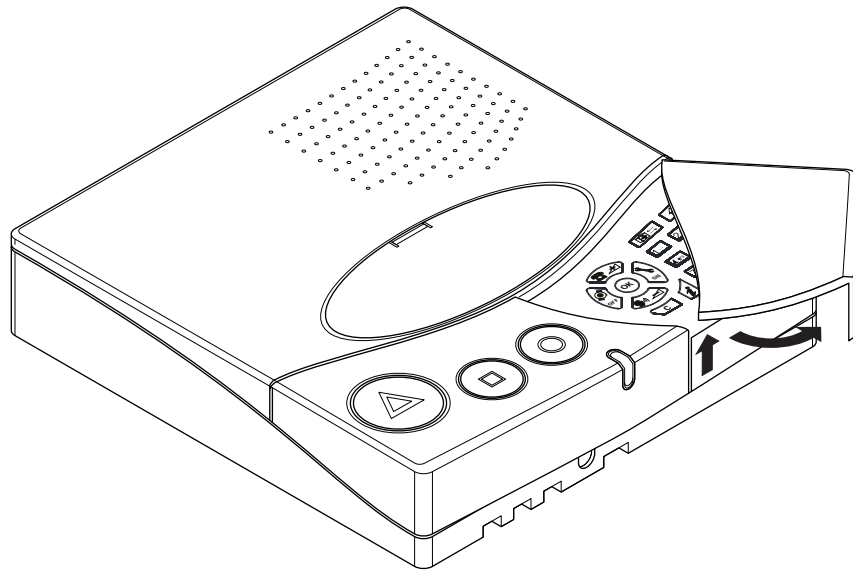

- ▶ To access the special settings programming, press **0-** three times quickly. See *Section 4.3 Special settings, page 21* for more details.

4.1.2 Exit and cancel entries

- ▶ Press **C** once or several times.

4.1.3 Key not allowed

- ▶ If you have pressed a key by mistake during the programming, a high-pitched beep is generated.

4.1.4 Locking and unlocking the keyboard

- ▶ Press ***T** then **#P** within one second to lock or unlock the keyboard.

This function locks only the keyboard to prevent any false manipulation. The colored buttons on the left hand side are still available.

When the keyboard is locked, a small lock appears at the bottom right of the display:

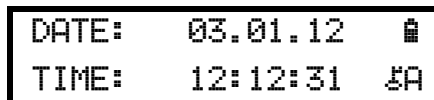

4.1.5 Programming time-out

- ▶ Programming of the NurseCall Relay Unit terminates automatically if no entries are made on the keyboard for more than **one minute**.

4.2 First use

4.2.1 List of original factory settings

Parameter	Original Factory Setting	Page
* Locating mode	On	20
* Identification number	No value	20
Assistance and fire priority	No	21
Special texts in German	No	22
Printer/display setup (Relay Plus Unit only)	None	22
Speaker volume	Midrange	25

* Locating mode and identification number are set at first use. To change a value, reset the unit. See *Section 4.3.2 Resetting all the parameters and buffers, page 21*.

4.2.2 Parameters set by the NurseCall Main Unit

The parameters listed below are programmed in the Main Unit and are applied to the Relay Unit. See the NurseCall Main Unit user manual.

- Display mode
- Unit language
- Date and time
- Local acknowledgement and the access code
- Output relay function and mode

4.2.3 Locating mode and identification number

1. Disconnect the NurseCall Relay Unit from the RS-485 bus.
2. Switch the NurseCall Relay Unit on with the switch located at the bottom of the unit. Wait for the following display to appear:

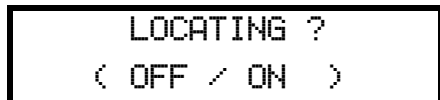

3. Enable (**ON**) or disable (**OFF**) the indication of the transmitter position (locating mode) on the NurseCall Relay Unit display. It must be the **same** as in the NurseCall Main Unit.

► Press  to disable or  to enable the locating mode.

4. The identification number of the NurseCall Relay Unit must now be attributed.

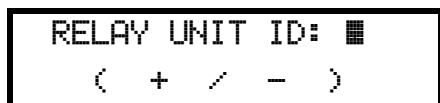



The identification number is attributed by the NurseCall Main Unit upon connecting the RS-485 bus corresponds to the order of connection. It can also be set manually. The range for this value is (A, B, C, ..., Y, Z, a, b, c, d, e, f) for a maximum of 32 Relay Units.

Automatic attribution by the NurseCall Main Unit

5.a. Press  or the **Red** button to erase any previous selection. The black box remains.

5.b. Connect the NurseCall Relay Unit to the RS-485 bus. Press  or the **Green** button to enable the automatic attribution. The next free identification number is attributed by the Main Unit and is displayed on the Relay Unit at the bottom right.

Manual selection of the NurseCall Main Unit

5.a. Scroll with  and  to set manually the identification number. Confirm with  or the **Green** button. The Relay Unit signals that it is not connected to the RS-485 bus.

```
NurseCall
RELAY UNIT OFF !!!
```

5.b. Connect the NurseCall Relay Unit to the RS-485 bus. The identification number is now displayed at the bottom right.

4.3 Special settings

After pressing  three times quickly, you can enter special codes.

```
Enter Code
```

4.3.1 Displaying the firmware version

1. Type the code **194155**.
2. The version of the firmware will be displayed for a few seconds.

```
Software REV A
U2.02 BN111.242.00A
```

4.3.2 Resetting all the parameters and buffers



CAUTION!

Disconnect the RS-485 bus before performing a reset. Reconnect it when you are finished.



NOTICE!

The following procedure resets the NurseCall Relay Unit to its original factory settings. It erases all the parameters, as well as the alarms and events buffers. This reset is mandatory if you wish to change the locating mode or the identification number.

1. Type the code **194156**.
2. When the unit resets, it plays a short melody and displays a temporary message.

```
Please Wait...
```

3. After a few seconds, the unit goes back to the first use display.
4. Select the locating mode and the identification number. See *Section 4.2 First use*.

4.3.3 Assistance and fire priority

This command sets the assistance call and the fire alarm as priority calls. This means that alarms of these types will be displayed first.

1. Type the code **123991**. The unit plays a melody and a confirmation message is displayed.

```
ASSISTANCE & FIRE
PRIORITY
```

4.3.4 Assistance and fire non priority

This command sets the assistance call and the fire alarm as non-priority calls. This means that the last alarm is displayed, whatever its type. This is the default value.

1. Type the code **123992**. The unit plays a melody and a confirmation message is displayed.

```
ASSISTANCE & FIRE
NONPRIORITY
```

4.3.5 Special texts in German

This command sets special texts in German. The displayed criteria are:

- BAD/WC instead of TECHNIK
- HILFE-2 instead of NOTRUF2

1. Type the code **123007**. The unit plays a melody and a confirmation message is displayed.

```
MULTITONE TEXTE
BAD/WC + HILFE-2
```

4.3.6 Standard texts in German

This command sets standard texts in German. This is the default value.

1. Type the code **123008**. The unit plays a melody and a confirmation message is displayed.

```
STANDARDTEXTE
TECHNIK + NOTRUF2
```

4.4 Printer/display setup on the Relay Plus Unit

4.4.1 Access to the printer/display setup menu



NOTICE!

The printer/display setup can only be configured on a NurseCall Relay Plus Unit connected to a NurseCall system via the RS-485 bus.

1. Press **OK** then  to access the programming menu.

```
% OK:Program
i:Info
```

2. Press **OK** to enter the RS-232 output menu or  to check the RS-232 output setup.

```
% Parameter Nr. 00
RS-232 Output. ↓
```

3. Press **OK** to enter the printer/display setup. Press  to escape.

4. Scroll with  and  to select one of the following:

- **None**
- **Printer**
- **DISPLAY ZETTLER**
- **DISPLAY NORSK**

4.4.2 Selection "None"

- if you have selected **None**, press  to confirm.

```
% RS-232 Output
None ↓
```

In this case, there will be no printer/display output. This is the default setting.



4.4.3 Selection "Printer"

- if you have selected **Printer**, press  to confirm.

```
% RS-232 Output
Printer ⌕
```

1. Set the printing of all the daily messages sent by transmitters.

```
% Printer
24h printed?:YES ⌕
```

2. Scroll with  and  to select **YES** or **NO**. Default value is **YES**.
3. Confirm with .

4.4.4 Selection "DISPLAY ZETTLER"

- if you have selected **DISPLAY ZETTLER**, press  to confirm.



```
% RS-232 Output
DISPLAY ZETTLER ⌕
```

1. Set the rotational display of alarms.





```
% DISPLAY ZETTLER
Rota.of Alarms:YES ⌕
```

2. Select **YES** or **NO** with  and . Default value is **YES**. Confirm with .
3. Set the display of the clock. The format is HH:MM.

```
% DISPLAY ZETTLER
Time displayed:YES ⌕
```

4. Scroll with  and  to select **YES** or **NO**. Default value is **YES**.
5. Confirm with .
6. Configure the display of the 10 identification positions . The outcome is visible at the top.

```
DISPLAY :CR ff rr b
CRITER. 2 + 1 SPACES
```

- a. Select a field with  and , change a value with  and .
- b. Confirm with .

- c. Choose **0** to **9** characters for the criterion, followed by **0** to **9** spaces.
Default values are **2** characters + **1** space.
7. Repeat the operation for
 - a. the floor (**0** to **3** characters and **0** to **9** spaces), by default **2** characters and **1** space
 - b. the room (**0** to **3** characters and **0** to **9** spaces), by default **2** characters and **1** space
 - c. the bed (**0** or **1** character), by default **1** character.

**NOTICE!**

Configuration of the display is possible only in display mode FL,RO,BE (floor, room, bed).
If the NurseCall system is in display mode NUMBER, there is no need of further programming.

4.4.5 Selection "DISPLAY NORSK"

**NOTICE!**

The display mode NUMBER ZZZZ (alphanumeric display) is not compatible with the Display Norsk. Make sure to choose another display mode when connecting a Display Norsk to the Relay Plus Unit. See the NurseCall Main Unit user manual for more information.

- if you have selected **DISPLAY NORSK**, press  to confirm.

```

% RS-232 Output
DISPLAY NORSK      ↑
  
```

1. Set the rotational display of alarms.





```

% DISPLAY NORSK
Rota.of Alarms: YES  Ⓚ
  
```

2. Select **YES** or **NO** with  and . Default value is **YES**. Confirm with .
3. Configure the display of the 6 identification positions. The outcome is visible at the top.

```

DISPLAY :   ffrrrb
FL: 2 +RO: 3 +BE: 1
  
```

- Select a field with  and , change a value with  and .
- Confirm with .
- Choose **0** to **9** characters for the criterion, followed by **0** to **9** spaces.
Default values are **2** characters and **1** space.
- 4. Repeat the operation for
 - the floor (**0** to **3** characters), by default **2** characters
 - the room (**0** to **3** characters), by default **3** characters
 - the bed (**0** or **1** character), by default **1** character.



**NOTICE!**

Configuration of the display is possible only in display mode FL,RO,BE (floor, room, bed).
If the NurseCall system is in display mode NUMBER, there is no need of further programming.

5 Operation

5.1 Adjusting the loudspeaker volume

When the NurseCall Relay Unit is in standby mode:

- ▶ Press  to increase the volume.
- ▶ Press  to decrease the volume.

5.2 Consulting the alarm or event buffer

The NurseCall Relay Unit uses an alarm buffer and an event buffer for display indication. The following alarms and messages are stored into the alarm buffer:

- call for help
- call for assistance
- reserve call (call for help 2)
- technical call
- fire alarm
- battery low message
- error message
- disconnection of a NurseCall Relay Unit from the RS-485 bus

If alarms are repeated, only the least recent entry remains in the buffer. The call for assistance replaces the call for help, the reserve call and the technical call in the alarm buffer.

In addition to all the alarms, all possible entries are stored in the event buffer.

The following messages are directly stored into the event buffer:

- acknowledgement N46, sent by an N46 Wall Transmitter, S35 or S37 Transmitters
- acknowledgement by S35 or S37 Transmitters
- local acknowledgement, an acknowledgement at the NurseCall Main Unit or Relay Unit
- daily message check
- personnel arrival message (A, B, C and D)
- personnel departure message
- power outage of a receiver unit
- return of power at a receiver unit
- backup battery low of a receiver unit
- interruption of the RS-232 connection interface between the NurseCall system and a PC
- return of the RS-232 connection interface between the NurseCall system and a PC
- connection of a NurseCall Relay Unit to the RS-485 bus
- transmission of the event "door" by a RAC Wireless Contact.



NOTICE!

The alarm and event buffers have a capacity of 18 or 100 entries. See the maximum number of events buffered, in the NurseCall Main Unit user manual.



The event buffer will normally be filled with the last 18 or 100 entries. In the alarm buffer, only the active alarms are present.

5.2.1

Switching between alarm and event buffers indication

The alarm buffer is indicated by default. If you are in the event buffer, the unit changes automatically to the alarm buffer after 1 minute without activity.

If there are no entries in the alarm buffer, the display shows the actual date and time.

- ▶ To switch from alarm to event buffer and vice versa, press .
- ▶ Scroll the alarms or the events with  and .
- ▶ Scroll the alarms only with the **Green** button.

5.2.2

Display indications

With the **Yellow** button, you can switch between three available information blocks. The following information is displayed when an alarm or a message arrives:

First information block

- In case of a "floor/room/bed" display mode:

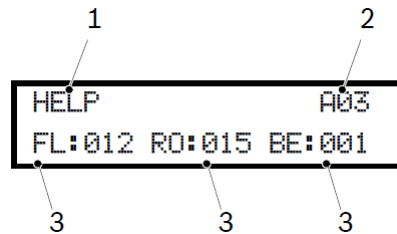

1. criterion of the alarm or message
2. alarm (A) or event (E) followed by its order in the buffer
3. identification of the transmitter location (floor/room/bed numbers)

- In case of "single number" display mode:

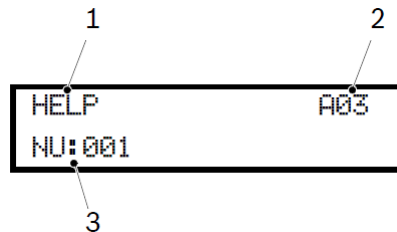

1. criterion of the alarm or message
2. alarm (A) or event (E) followed by its order in the buffer
3. identification of the transmitter location (three digits or four signs)

Second information block

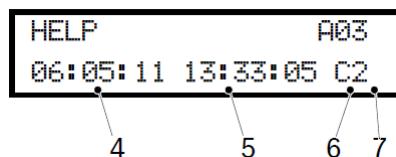

4. date of the event;
5. time of the event;
6. main unit (space) or relay Unit (A...f) identification number;
7. quality of the received radio signal.

This information is visible in all display modes.

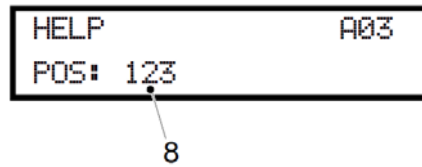
Third information block

8. position of the last passed beacon, visible in all display modes. If no beacon is registered or if the alarm is sent outside of the range of a beacon, the POS **000** will be displayed.

In the alarm buffer, the total number of entries is indicated on top at the right. You can immediately see how many alarms are active. In this example, there are a total of three alarms in the alarm buffer. In the event buffer, the position of the event in the buffer is indicated:

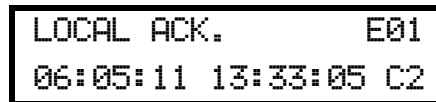

Here, E01 corresponds to the latest entry in the event buffer.

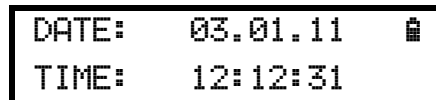
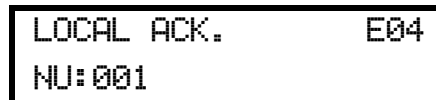
Unit displaying the current date and time:**Unit displaying an active alarm:****Unit displaying an event in the buffer:****5.2.3****The green button does not work**

Problem: you have tried unsuccessfully to acknowledge an alarm with the **Green** button.

Cause: the local acknowledgement is disabled.

Solution: activate the local acknowledgement function.

See the NurseCall Main Unit user manual.

5.2.4**Disconnecting a Relay Unit**

If a Relay Unit stops communicating with the Main Unit, an alarm "Relay Off" is generated on the Main Unit. This alarm can only be acknowledged on the Main Unit by pressing the **Green** button, followed by the code **45**. Thereafter, an event "No Relay" is generated.

As soon as the Relay Unit communicates again with the Main Unit, the Event "Relay On" is generated. This operation is independent of the local acknowledgement setting.

6 Maintenance

6.1 Checking the system

Check the correct function of your NurseCall system.

- ▶ Perform periodically an alarm test.

6.2 Monitoring the power supply

In case of a power failure, the NurseCall Relay Unit emits a beep and the following message is displayed alternatively with the date and time display:

```
Main Power
Error
```

The backup battery ensures that the NurseCall Relay Unit remains operational even in the case of a power failure. When fully charged, the battery ensures a power backup of 24 hours. When power returns after a power failure, the battery is recharged. If it has been completely discharged, it will reach its full capacity after 24 hours of charging time.

6.3 Monitoring the backup battery

The status of the battery is indicated on the top right of the display.

- ▶ To check the backup battery voltage, press . The following message is displayed:

```
Checkins
Local Battery
```



NOTICE!

At startup, an automatic check is made.

During normal operation, an automatic check is made every 30 minutes.

- ▶ If the remaining battery capacity drops below 25 %, the following message is displayed:

```
Local Battery
Empty
```

- ▶ If the NurseCall Relay Unit detects that the backup battery is defective, the following message is displayed:

```
Local Battery
Failure
```



NOTICE!

If the backup battery is defective, replace it as described in *Section 6.5.2 Backup battery replacing, page 30*.

6.4 Cleaning

- ▶ Avoid using cleaning products or detergents.
- ▶ Wipe off your NurseCall Relay Unit occasionally with a dry cloth.

6.5 Parts replacement

6.5.1 Disassembling the unit

Removing the antenna

1. Remove the antenna (1) and its adapter (2) or (3).

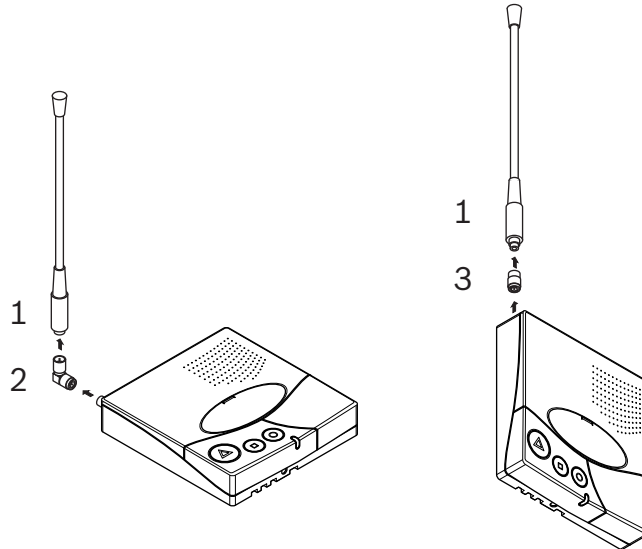

Removing the communication board



DANGER!

Do not damage the battery cable, its connector (7) or the serial communication board connectors.

1. With a Torx T20 screwdriver, unscrew and remove the 4 screws (4).
2. With a Torx T10 screwdriver, unscrew and remove the screw (5).
3. Carefully remove the communication board (6).

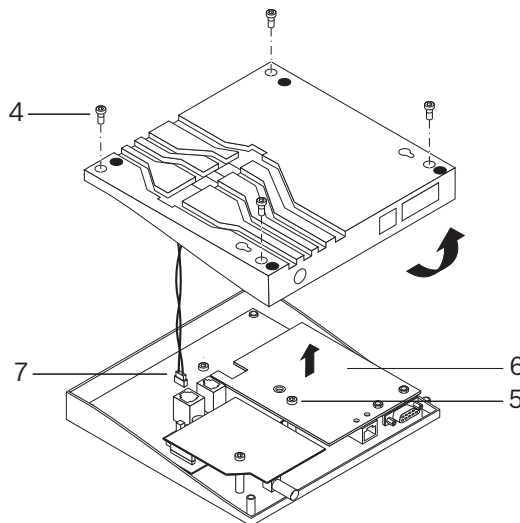

6.5.2 Backup battery replacing

Important Safety Instructions

The battery should charge for 24 hours before using the NurseCall Relay Unit for the first time, after replacing the battery or after a long power shortage. Battery type is 6V NiMH.



NOTICE!

The battery will charge correctly between 5 °C (41°F) and 45 °C (113 °F). A battery that is new or that has not been used for a long time can have reduced capacity at first use.

A rechargeable battery can be charged and discharged many times. However, it will eventually wear out. This is not a defect. It is recommended to replace batteries that cannot ensure a minimum power back-up time of 8 hours at full charge.

CAUTION!

- May explode if exposed to fire.
- Use only original batteries intended for your NurseCall Relay Unit.
- Do not expose the battery to liquids.
- Do not let the battery's contacts touch another metal. This could damage the battery;
- Do not disassemble or modify the battery;
- Do not expose the battery to extreme temperatures, and never above 60 °C (140 °F).
- For maximum battery capacity, use the battery at room temperature;
- Keep out of reach of children;
- Use the battery for the intended purpose only;
- Do not put the battery in the mouth. Battery electrolytes may be toxic if swallowed.



CAUTION!

There is a risk of explosion if battery is replaced by a wrong type. The battery should be replaced exclusively by authorized personnel. Dispose of used batteries according to instructions and regulations.



Procedure

1. Disassemble the unit as described in *Section 6.5.1 Disassembling the unit, page 29*.
2. Disconnect the battery cable (1).
3. Carefully remove the backup battery (2).
4. Place the new backup battery.
5. Connect the new battery cable (1).

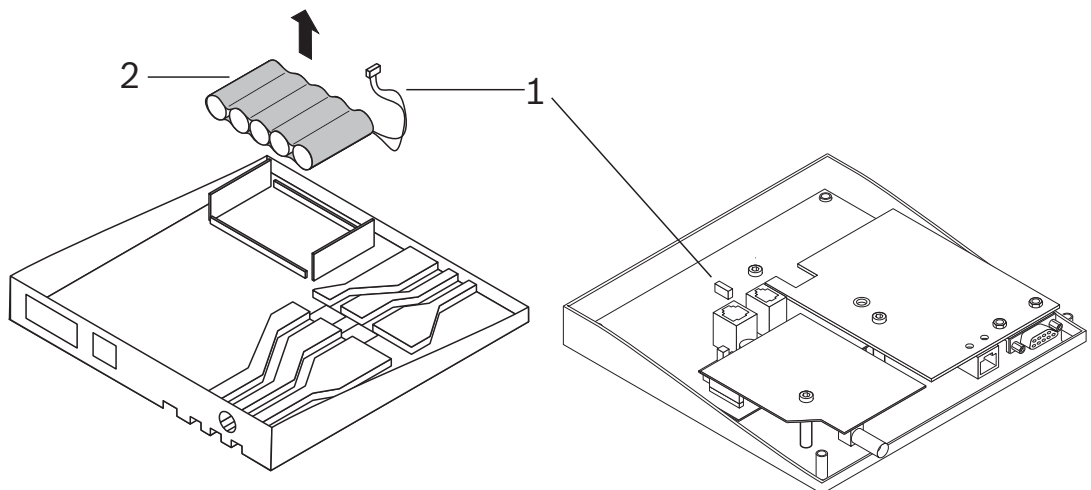

7 Disposal

The NurseCall Relay Unit is marked with a crossed-out wastebasket symbol. This means that, at the end of its lifetime, the product should be disposed separately from ordinary household waste in accordance with the EU Directive 2002/96/EC. The product and its accessories should be delivered to an appropriate collection facility that ensure recycling, treatment and an environmentally compatible disposal. This prevents any negative impact on the environment and human health, and promotes the recycling of materials. For more information on available collection facilities, contact your local waste collection service or your local representative.

7.1 Disassembly

Only authorized personnel are allowed to disassemble a NurseCall Relay Unit.

7.2 Returning to the manufacturer

If there is no practical disposal place, the NurseCall Relay Unit may be returned to your local representative.

7.3 Materials

The NurseCall Relay Unit must be returned to an authorized point of recycling. In order to protect people and environment, the NurseCall Relay Unit must be recycled in an adequate manner. Consequently, all applicable laws and bylaws must be respected.

7.4 Battery

**NOTICE!**

The battery should be disposed of as household waste. Use a battery disposal facility when available.

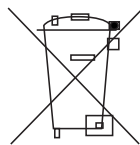

- ▶ Please check local regulations for disposal of batteries or call your local representative for information.

A Appendix

A.1 Electrical specifications

Voltage	230 or 115/10VAC
Current	280 mA
Frequency	50/60 Hz
Power	2.8 W max.

A.2 Dimensions and weight

Casing dimensions	[mm]
Depth	220
Width	180
Height	40

Antenna	[mm]
Height	400

Casing weight	[g]
Weight (including antenna and power supply adaptor)	740

A.3 Environmental conditions

Operating temperature	0 - 40°C
-----------------------	----------

A.4 List of criteria

Criterion	Number	Alarm (A) or Event (E)	Comment
ERROR	00	A	System malfunction, e.g. component defective
PERSONNEL A	01	E	Coded key active (N46)
LOW BATTERY	02	A	Battery at low level (Transmitter)
ACK. N46	03	E	Acknowledgement (Sent by N46, S35 or S37)
DOOR	04	E	Door open or door closed
TECHNICAL	05	A	Technical Call (N46)
PERSONNEL C	06	E	Coded key presence (N46)
HELP	07	A	Call for Help
UNKNOWN	08	E	Not used
END PERSONNEL	09	E	Removed coded key (N46)
PERSONNEL D	10	E	Coded key presence (N46)
ASSISTANCE	11	A	Assistance Call
24 HOURS	12	E	Daily message check
RESERVE	13	A	Reserve Call (N46)
PERSONNEL B	14	E	Coded key presence (N46)
RADIO NOISE	15	E	Bad radio transmission (noise)
FIRE	16	A	Fire Alarm
ACK. TRANSM.1	17	E	Acknowledgement (Ack. Transmitter No. 1)
LOCAL ACK.	18	E	Local Acknowledgement (Main Unit or Relay Unit)
POWER OUTAGE	19	E	Main Unit or Relay Unit not powered
POWER BACK	20	E	Power back (Main Unit or Relay Unit)
COMPUTER OFF	21	E	Alarm management PC off
COMPUTER ON	22	E	Alarm management PC on
BAT.ACK.TRANSM	23	E	Battery at low level (One of the Ack. Transmitter)
RELAY ON	24	E	Relay Unit connected on RS-485 Bus
RELAY OFF	25	A	Relay Unit disconnected from RS-485 Bus
NO RELAY	26	E	Relay Unit off acknowledged (Main Unit)
LOW ACCU	27	E	Accumulator discharged (Main Unit or Relay Unit)
ACK. TRANSM.2	28	E	Acknowledgement (Ack. Transmitter No. 2)
ACK. TRANSM.3	29	E	Acknowledgement (Ack. Transmitter No. 3)
ACK. TRANSM.4	30	E	Acknowledgement (Ack. Transmitter No. 4)
ACK. TRANSM.5	31	E	Acknowledgement (Ack. Transmitter No. 5)
ACK. TRANSM.xx	xx	E	Acknowledgement (Ack. Transmitter No. xx)
ACK. TRANSM.32	58	E	Acknowledgement (Ack. Transmitter No. 32)
DEMENTIA	60	A	Dementia Alarm



NOTICE!

All events are buffered into the event buffer of the NurseCall Relay Unit. All alarms and events are sent to the printer/display. All alarms and events except the events "COMPUTER OFF" and "COMPUTER ON" are sent to the Alarm management Software.

A.5 Connectors

A.5.1 LINE socket (unit bottom)

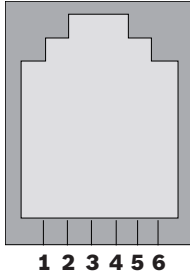
LINE socket	Wiring
	<ol style="list-style-type: none"> 1. Flash Data GND 2. Not used 3. Not used 4. Not used 5. Not used 6. Flash Data IN/OUT

A.5.2 Power socket (unit bottom)

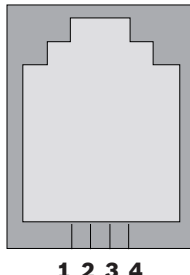
10V AC socket	Wiring
	<ol style="list-style-type: none"> 1. Not used 2. AC-1 10-12VAC 3. AC-2 4. GND

A.5.3 RS-232 socket (Relay Plus Unit rear)

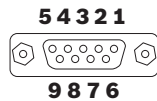
RS-232 socket	Wiring
	<ol style="list-style-type: none"> 1. --- 2. TXD (RXD) 3. RXD (TXD) 4. --- 5. GND 6. --- 7. --- 8. --- 9. ---

A.5.4 RS-485 socket (unit rear)

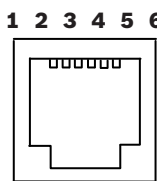
RS-485 socket	Wiring
	<ol style="list-style-type: none"> 1. Relay output (a) 2. RS485 (A) 3. Termination = RS485 (A) 4. RS485(A) when jumper end line is placed 5. RS485 (B) 6. Relay Output (b)

Bosch Security Systems

Robert-Bosch-Ring 5
85630 Grasbrunn
Germany

www.boschsecurity.com

© Bosch Security Systems, 2011